

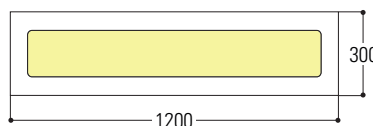

# VERT RETICULA

LED TECHNOLOGY

Edge 90°

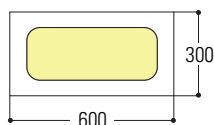
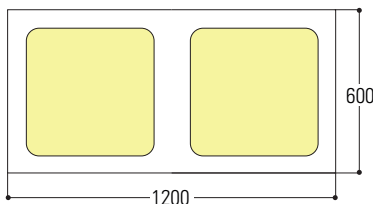
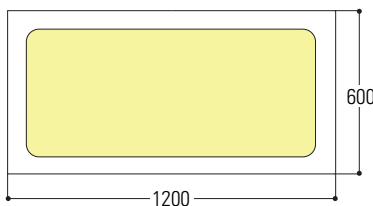
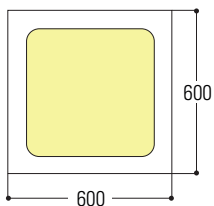
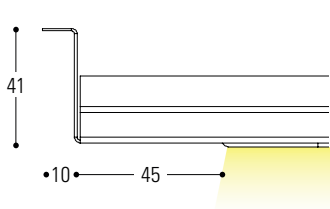

## DESCRIPTION

Recessed luminaire for lighting with high-yield LED technology. An elegant and modern style guaranteed by integration within the cell ceiling system. The luminaire consists of an aluminium structure and a cladding panel with the same material (aluminium or steel) and the same finish (pre-painted or post-painted) as the false ceiling and replaces all applications that hitherto involved the use of fluorescent and halogens.

## TECHNICAL CHARACTERISTICS

<b>Panel material:</b>	Aluminium (Alloy 3000H46) Galvanised steel
<b>Ceiling light material:</b>	Aluminium (Alloy 3000H46)
<b>Colour:</b>	Prepainted DONN-WHITE Silver Mirror-coated aluminium Post-painted RAL-NCS-Sublimed
<b>Panel thickness</b>	0,4 - 0,5 - 0,6 mm
<b>Body thickness:</b>	0,8 mm
<b>Internal driver:</b>	Yes
<b>Features:</b>	DALI module Night light Presence sensor with self-adjustment Emergency module
<b>Standard modules:</b>	600x600 mm with 90° edge 600x1200 mm with 90° edge 300x600 mm with 90° edge 300x1200 mm with 90° edge
<b>Service life:</b>	50.000 hours
<b>LED Warranty:</b>	3 Years
<b>Product weight:</b>	4 kg

## ADVANTAGES AND APPLICATIONS

Cell ceiling system

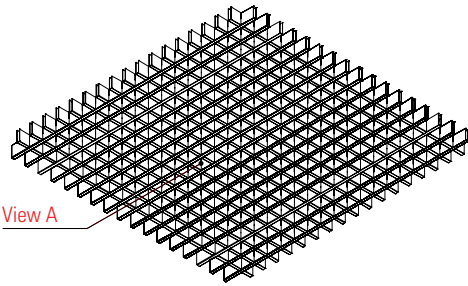

Cell ceiling system with ceiling light

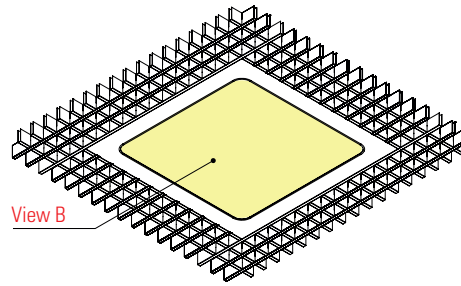

### DESCRIPTION

The **Vert Reticula** ceiling light with its modern design allows perfect integration into the cell ceiling system. The ceiling luminaire is mounted flush with the entire system and, thanks to a cover positioned above the cell ceiling, provides total shielding from the attic so that it can be used as a screen so as not to create light leakage. The entire system together with the ceiling light is accessible at any point.

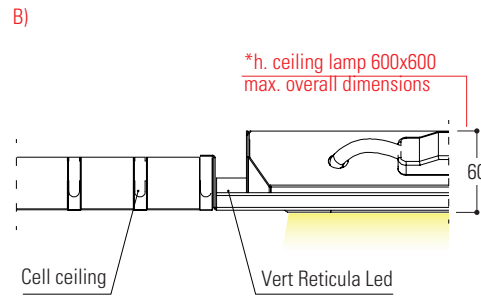
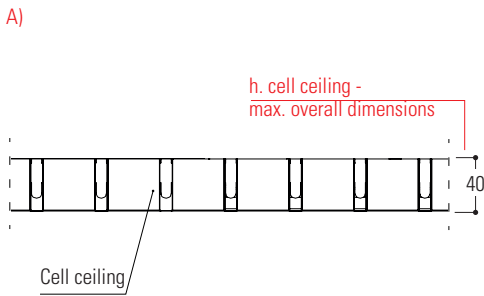

*ceiling light footprint:	module 600x600 60 mm
	module 600x1200 60 mm
	module 300x600 60 mm
	module 300x1200 60 mm

## MODULES AND DIMENSIONS

Different solutions are possible; with the possibility of different modules you are able to create the right solution and meet every requirement.

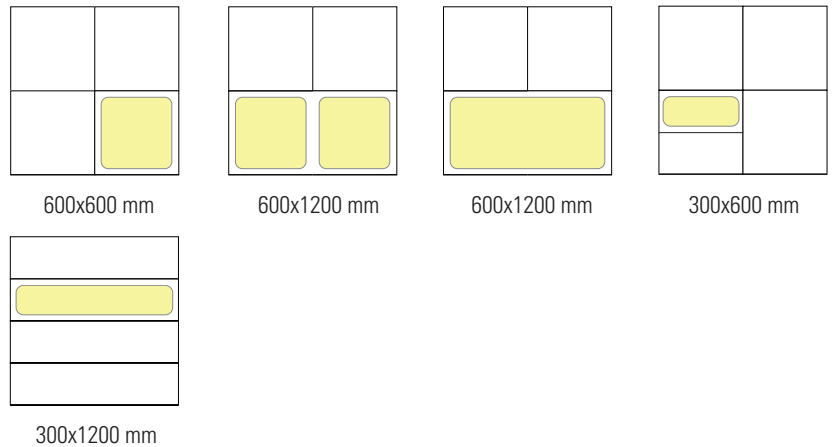
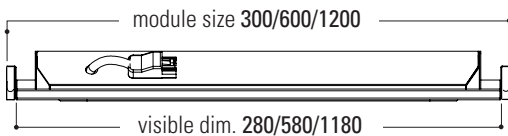

## PERFORMANCE AND CONSUMPTION

The **Vert Reticula** is designed to offer homogeneous, flicker-free lighting suitable for installation in any location where optimum visual performance is required. This LED panel offers excellent lighting performance for up to approximately 50.000 hours, with an estimated daily usage of 8 hours. Thanks to the integrated LED technology, this panel replaces old installations with halogen tubes with significantly lower consumption. The LED system therefore drastically lowers consumption while maintaining the same light intensity.

Type	Dimensions	Power (W)	Luminous flux Lamp** (IM)	Luminous flux Lamp** (IM)
			OPALE	UGR
Vert Reticula Led 84	300x600	32	4000	3500
Vert Reticula Led 100	600x600	40	3500	3200
Vert Reticula Led 144*		55	5300	6000
Vert Reticula Led 200		80	7000	6300
Vert Reticula Led 265*		89	8800	9800
Vert Reticula Led 192	300x1200	70	6300	7500
Vert Reticula Led 576	600x1200	-	-	-
Vert Reticula Led 100+100	600x1200	80	-	6060

# EMERGENCY MODULE

An emergency module can be integrated into the ceiling light, which guarantees a lighting autonomy of up to 3 hours even in the absence of electricity. This module is equipped with the standards shown in the table.

Autonomy	Capacity	Regulations	
3h	4,2 Ah	CEI 61000-6- 3	CEI 2004/108
		CEI EN 6154 7	CE 2006/95
IEC 60598-2-22		CEI EN 61000-4- 8	EN 6052 9

# OPTICAL GROUP

- Color rendering CRI>90 (CRI 80 available upon request)
- Photobiological risk 0 (exempt) protected from UV rays EN 62471
- Color temperature 3000K, 4000K and 6000K
- (LED diode selected 3 steps Mac Adam)
- Useful life (L93/B10): 30000 h. (tq+25°C)
- Useful life (L90/B10): 50000 h. (tq+25°C)
- Useful life (L85/B10): 80000 h. (tq+25°C)

Standard available colour temperature



Available optics:

version UGR<19 (UGR)

Microprismatic polycarbonate optics for environments with video terminals

Standard Version (OP) N.B the OP version is supplied on specific request

Plexiglass LED optics with high light transmission for uniform brightness

# PHOTOMETRIC CURVES

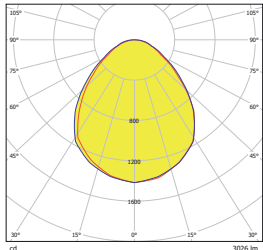

Vert Reticula Led 84 32W UGR

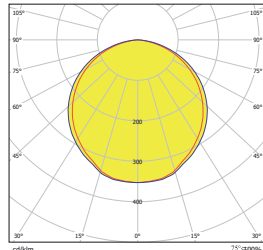

Vert Reticula Led 84 38W OP

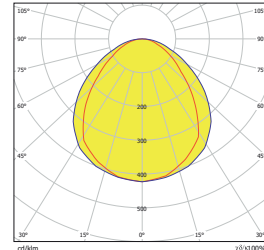

Vert Reticula Led 192 70W UGR

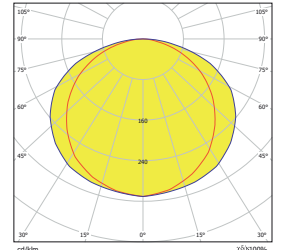

Vert Reticula Led 192 75W OP

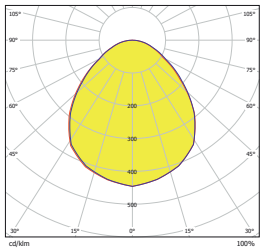

Vert Reticula Led 100 40 W UGR

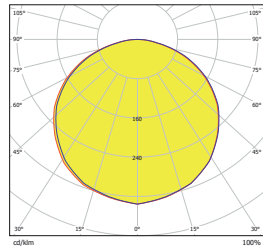

Vert Reticula Led 100 40 W OP

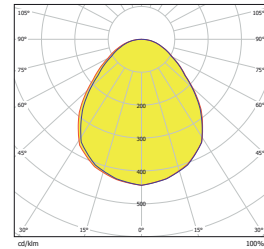

Vert Reticula Led 144 55W UGR

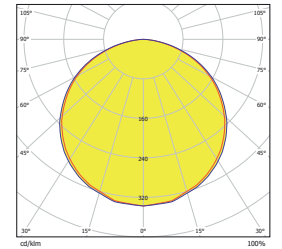

Vert Reticula Led 144 56W OP

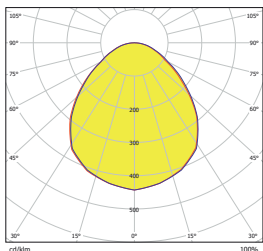

Vert Reticula Led 200 80 W UGR

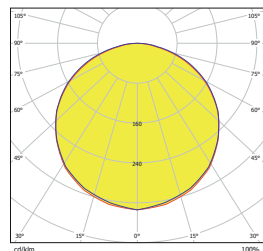

Vert Reticula Led 200 80 W OP

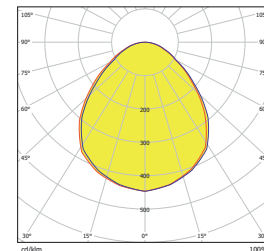

Vert Reticula Led 265 89 W UGR

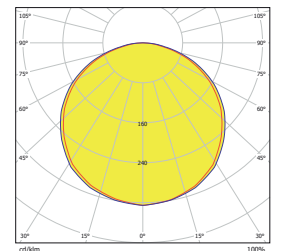

Vert Reticula Led 265 90 W OP

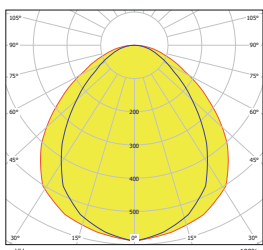

Vert Reticula Led 100+100 80 W UGR

## SYSTEM ELEMENTS

1. Vert Reticula
2. Power supply
3. Cell ceiling profile

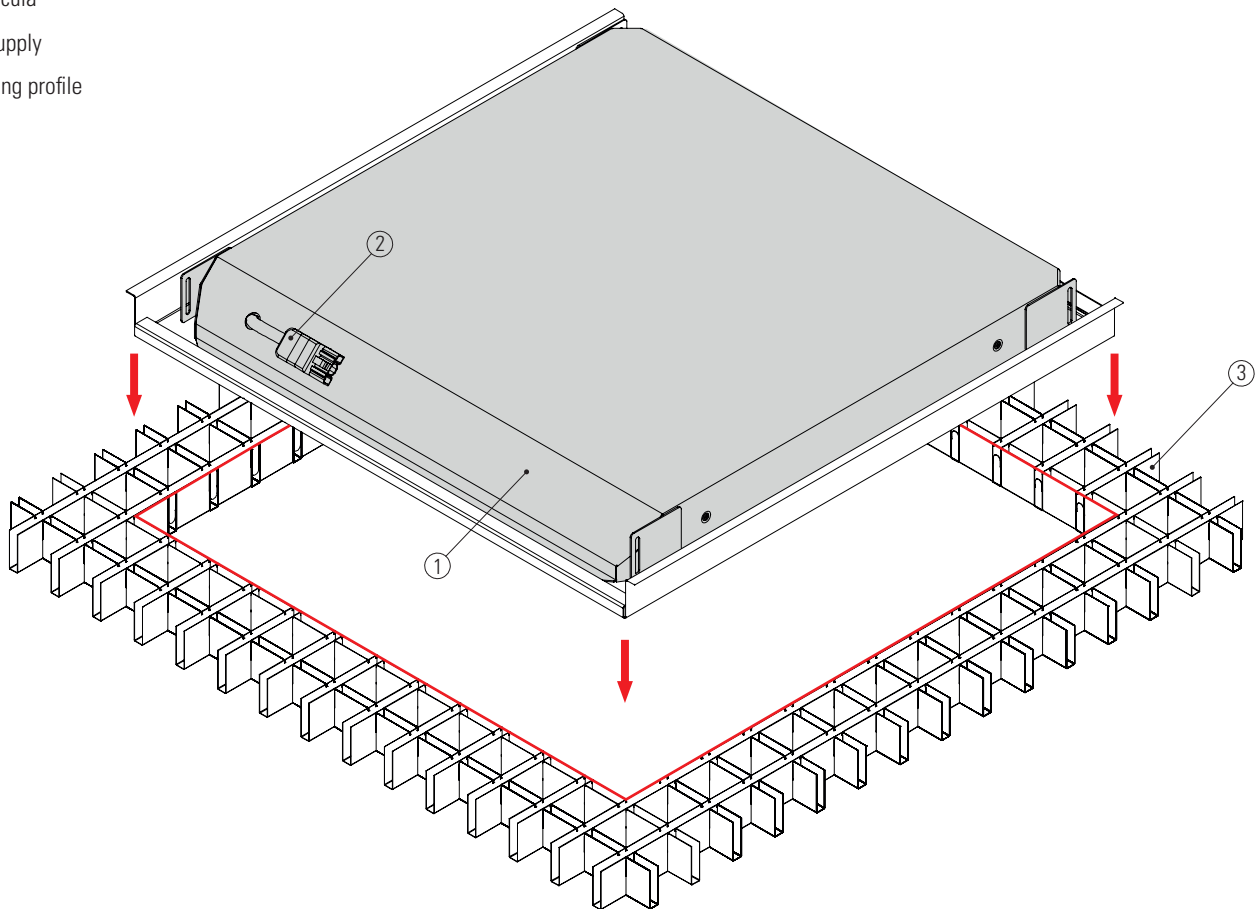

## ASSEMBLY DESCRIPTION

Vert Reticula is assembled in a few simple and intuitive steps:

1. Position and centre the ceiling light(1) between the profiles (3)
2. Insert the ceiling light(1) at an angle, positioning it above the profiles.
3. Place the ceiling light(1) on the profiles(3)
4. Connect the ceiling light(2) to the power supply using the power supply socket and leave it in place after installing the suspensions (slotted bars) on the ceiling light.

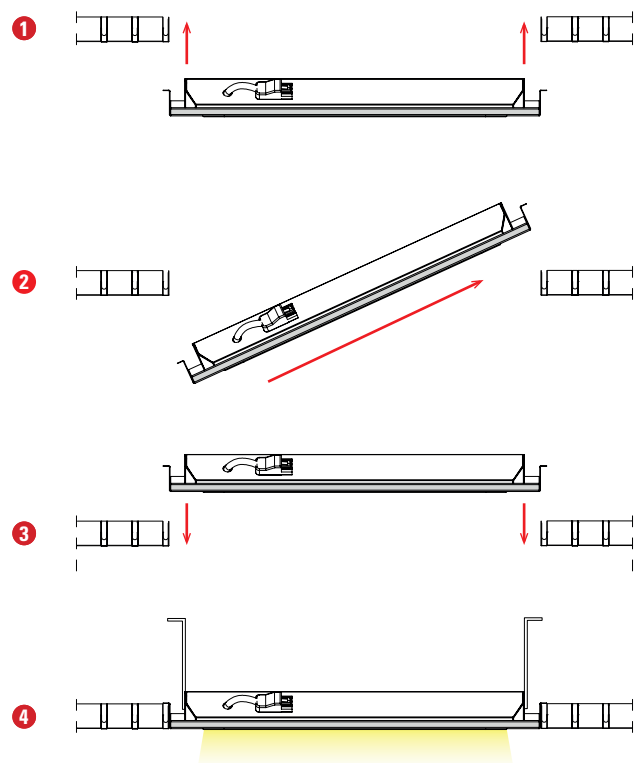

# VIEW POSITIONING FROM ABOVE

## SYSTEM ELEMENTS

1. Vert Reticula
2. Power supply
3. Cell ceiling profile
4. BA suspension
5. Suspension guerr.003

## INSTALLATION EXAMPLE

- **VERT RETICULA:** surface-installed
- **PROFILES:** installation in lay-on

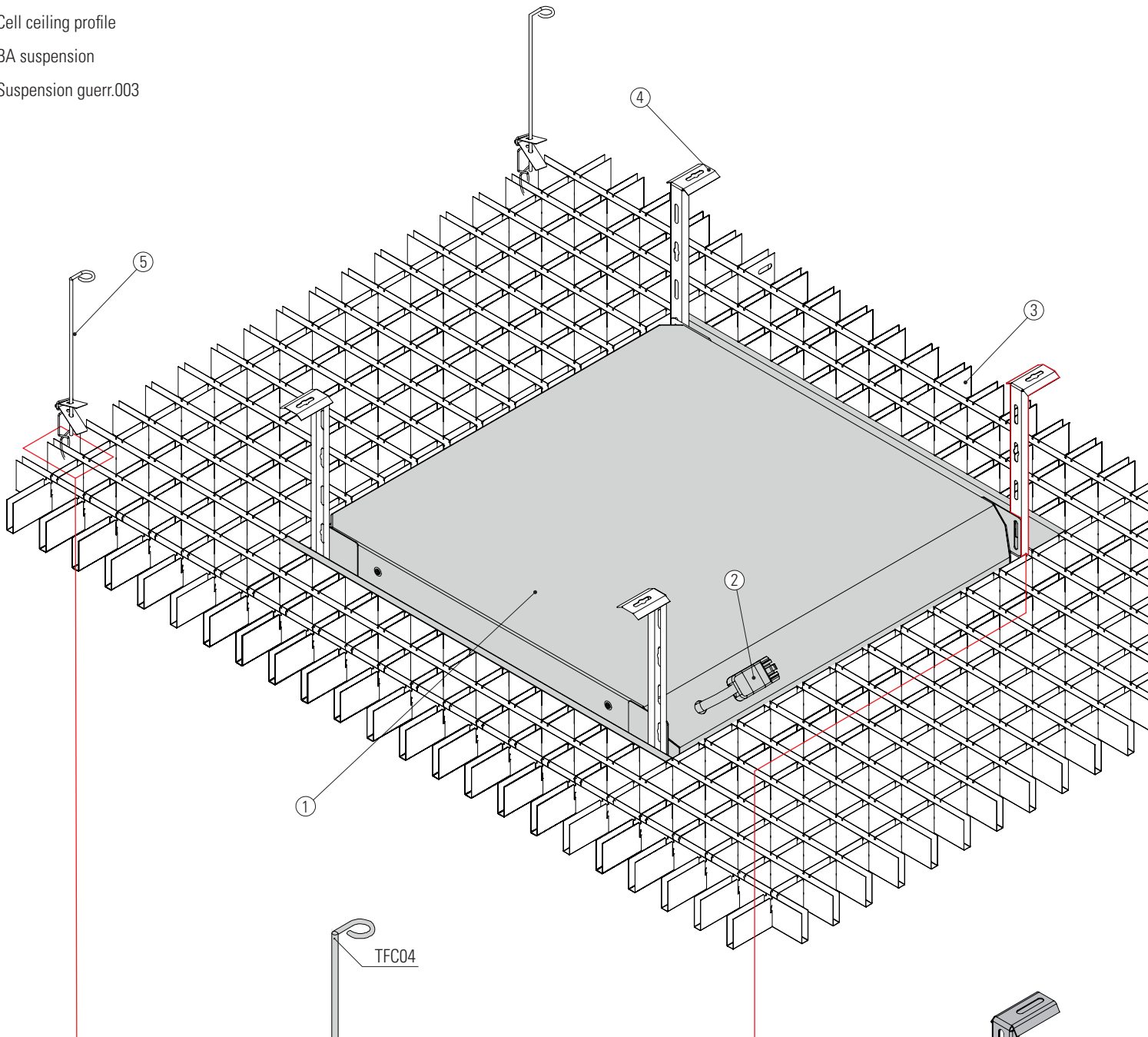

### DETAILS STRUCTURE SUSPENSION

Shown in detail is the suspension that can be applied to the grating system, which provides practicality during assembly and a high level of strength, for more information download the 'Slats and Gratings' catalogue at [www.vertebra.com](http://www.vertebra.com)

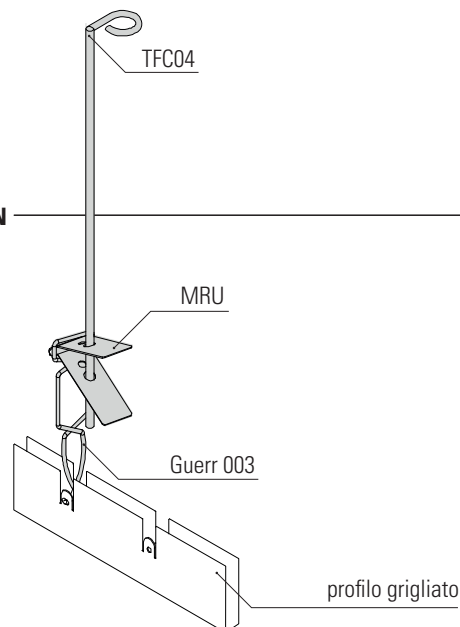

### CEILING SUSPENSION DETAILS

Detail shows the rigid and independent suspension of the ceiling frame grating profile

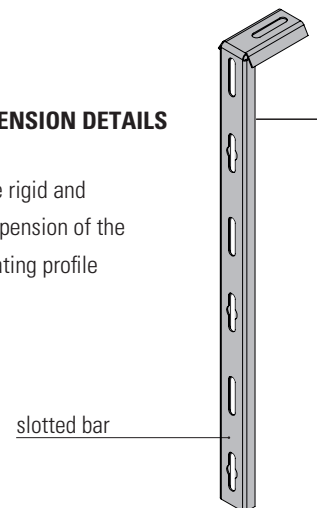

# POWER SUPPLY SOCKET AND SEAL

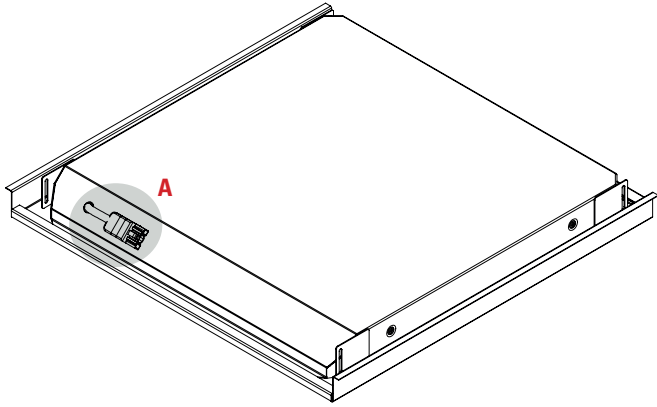

## A: POWER SUPPLY

- 230/240 - 50/60 Hz power supply with 0.75 mm<sup>2</sup> cross-section cable and PVC-HT sheathing, flame retardant in accordance with CEI 20-35 and complying with CEI 20.20 and CEI CENELEC HD 21 standards. IP66 watertight connector 2P+E or 4P+E, maximum allowed cable cross-section 2.5 mm<sup>2</sup>.

Insulation class I.

Suitable for installation on normally flammable surfaces.

- Power supply EEI=A2 230-240, 50 - 60Hz. power factor > 0.95.



## OTHER EQUIPMENT

Possible equipment of the Microprocessor Self-Test Module equipped with:

- Autonomy test
- Functionality test
- Routine tests

\*\*Luminous flux tolerance ±10%.

\*Dual Power possibility

\*RGB - DMX/ DALI system with localised touch panel

\*\*Power subject to minor (±5%) variations without notice

\*/\*\* see table page 2

## WARNINGS

### General Warnings

- The luminaire is constructed in a workmanlike manner, and its electrical life will be more than sufficient if used correctly.
- Please read the following warnings carefully as they are important information for safe installation, use and maintenance.
- After removing the appliance from its packaging, ensure that it is undamaged, otherwise contact the seller.
- Packaging elements (plastic bags etc.) must not be left within reach of children as they are potential sources of danger.
- Before connecting the appliance, make sure that the rating plate data correspond to those of the electrical distribution network to which the appliance will be connected (the label with the rating plate data is located on the outside of the appliance).
- Before carrying out any cleaning or maintenance operations, disconnect the appliance from the mains power supply by switching off the circuit breaker; in the event of a fault, contact only professionally qualified personnel.
- Failure to do so may compromise the safety of the appliance.
- The manufacturer cannot be held liable for any damage resulting from improper, incorrect and unreasonable use.

### Important warnings

- The product must not be subject to modification, any modification voids the warranty and may render the product dangerous.
- Antonio Guerrasio s.r.l. shall not be held liable for any damage caused by its products not being assembled in accordance with the instructions.
- Any damaged components must be replaced with similar ones.
- The products must be installed in a workmanlike manner.
- In order to avoid dangerous overheating, it is recommended not to install the appliance in cramped spaces without air exchange.
- The appliance is also intended for installation on normally flammable surfaces.

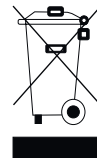

### Recycling

In implementation of Directives 2002/95/EC, 2002/96/EC and 2003/108/EC ("on the reduction of the use of hazardous substances in electrical and electronic equipment and the disposal of waste") the crossed-out wheeled bin serves as a reminder to collect the product separately from other waste at the end of its life or to return it to the retailer when purchasing a new appliance of an equivalent type. This helps to preserve the environment from contamination and promotes the recycling of equipment components. Unauthorised disposal is subject to sanctions in accordance with the law.



IP43



Features subject to change and improvement without notice