

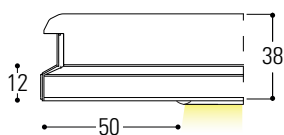

# VERT BOXLIGHT

LED TECHNOLOGY

Edge A



Edge B

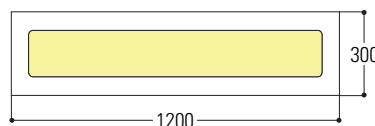
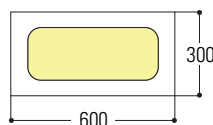
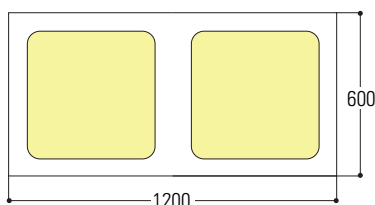
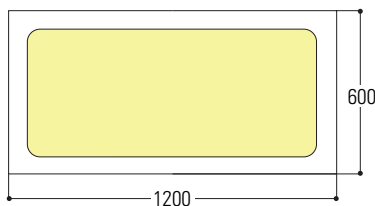
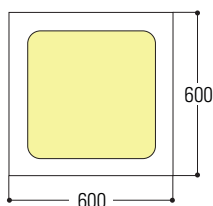
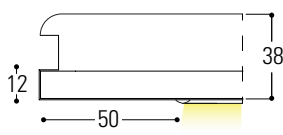

## DESCRIPTION

Recessed lighting fixture with high light output LED technology. An elegant and modern style guaranteed by integration into the Vert Box type ceiling. The luminaire is composed of an aluminium and a cladding panel that has the same material (aluminium or steel) and the same finish (pre-painted or post-painted) as the false ceiling, and replaces all applications that so far required the use of fluorescent and halogen tubes.

## TECHNICAL CHARACTERISTICS

<b>Panel material:</b>	Aluminium (Alloy 3000H46) Galvanised steel (DX51DZ)
<b>Ceiling light material</b>	Aluminium (Alloy 3000H46)
<b>Colour:</b>	Prepainted white DONN-WHITE Silver Mirror polished aluminium Post-painted RAL-NCS-Sublimed
<b>Panel thickness:</b>	0,4 - 0,5 - 0,6 mm
<b>Body thickness:</b>	0,8 mm
<b>Internal driver:</b>	Yes
<b>Features:</b>	DALI module Night light Presence sensor with self-adjustment Emergency module
<b>Standard modules:</b>	600x600 mm with 90° edge 600x1200 mm with 90° edge 300x600 mm with 90° edge 300x1200 mm with 90° edge
<b>Service life:</b>	50.000 hours
<b>LED warranty:</b>	3 Years
<b>Product weight:</b>	4 kg

## ADVANTAGES AND APPLICATIONS

### Vert Box System

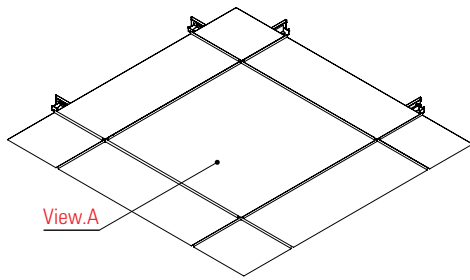

### Vert Box system with ceiling light

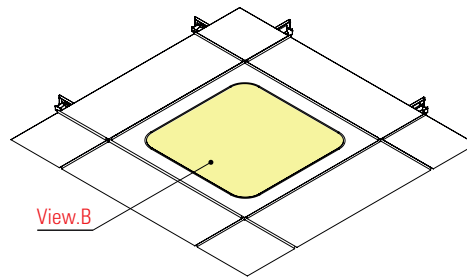

### DESCRIPTION

The Vert Box Light ceiling light with its modern design allows perfect integration into the Vert Box system, which consists of a T-structure and a panelling that follows the lines and design of the ceiling light, enhancing the entire mounted system even more. The system is in a semi-hidden frame and creates 10-mm shadow zones with the possibility of being accessed from each point.

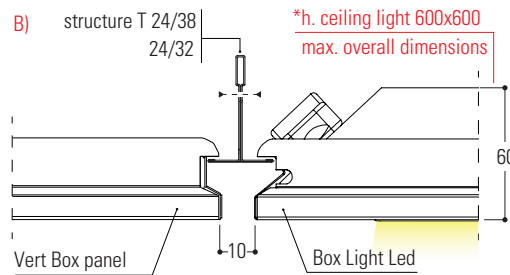
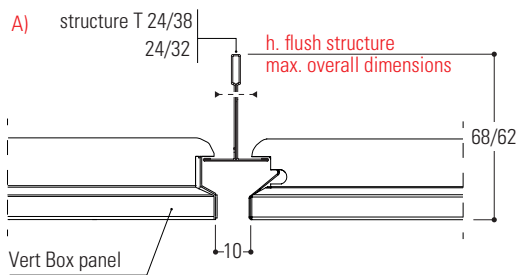

*overall ceiling light :	module 600x600 60 mm
	module 600x1200 60 mm
	module 300x600 60 mm
	module 300x1200 60 mm

## STANDARD MODULES

Various solutions are possible; with the possibility of different modules you are able to create the right solution and meet every requirement.

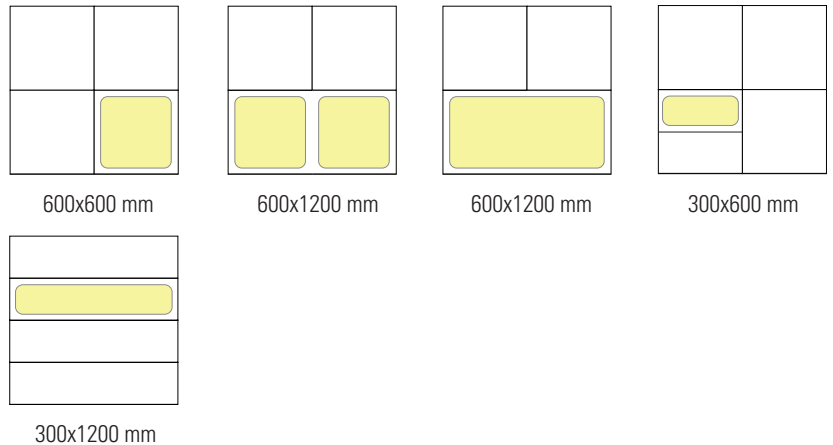
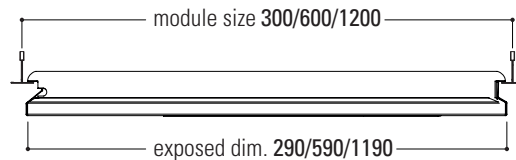

## PERFORMANCE AND CONSUMPTION

The **Vert Box Light** is designed to provide even, flicker-free lighting suitable for installation in any location where excellent visual performance is required.

This LED panel offers excellent lighting performance for up to approximately 50,000 hours, with an estimated daily usage of 8 hours. Thanks to the integrated LED technology, this panel replaces older installations with halogen tubes with significantly lower consumption. The LED system, therefore, drastically lowers consumption while maintaining the same light intensity.

Type	Dimensions	Power (W)	Luminous flux Lamp** (IM)	
			OPAL	UGR
Vert Box Light 84	300x600	32	4000	3500
Vert Box Light 100	600x600	40	3500	3200
Vert Box Light 144*		55	5300	6000
Vert Box Light 200		80	7000	6300
Vert Box Light 265*		89	8800	9800
Vert Box Light 192	300x1200	70	6300	7500
Vert Box Light 576	600x1200	-	-	-
Vert Box Light 100+100	600x1200	80	-	6060

# EMERGENCY MODULE

An emergency module can be integrated into the luminaire, which guarantees a lighting autonomy even in the absence of electricity for up to 3 hours. This module is equipped with the standards shown in the table.

Autonomy	Capacity	Regulations	
3h	4,2 Ah	CEI 61000-6- 3	CEI 2004/108
		CEI EN 6154 7	CE 2006/95
IEC 60598-2-22		CEI EN 61000-4- 8	EN 6052 9

# OPTICAL GROUP

- Color rendering CRI>90 (CRI 80 available upon request)
- Photobiological risk 0 (exempt) protected from UV rays EN 62471
- Color temperature 3000K, 4000K and 6000K (LED diode selected 3 steps Mac Adam)
- Useful life (L93/B10): 30000 h. (tq+25°C)
- Useful life (L90/B10): 50000 h. (tq+25°C)
- Useful life (L85/B10): 80000 h. (tq+25°C)

Standard available colour temperature



**Available optics:**

**version UGR<19 (UGR)**

Microprismatic polycarbonate optics for environments with video terminals

**Standard Version (OP) N.B** the OP version is supplied on specific request

Plexiglass LED optics with high light transmission for uniform brightness

# PHOTOMETRIC CURVES

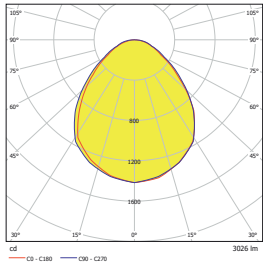

Vert Box Light 84 32W UGR

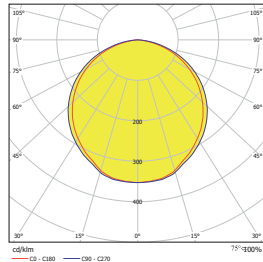

Vert Box Light 84 38W OP

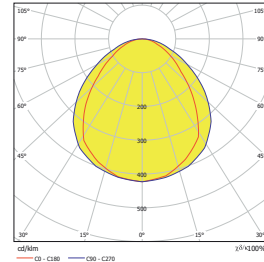

Vert Box Light 192 70W UGR

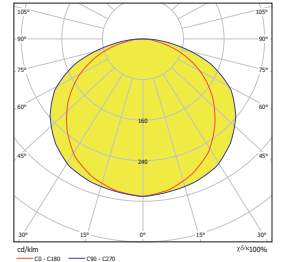

Vert Box Light 192 75W OP

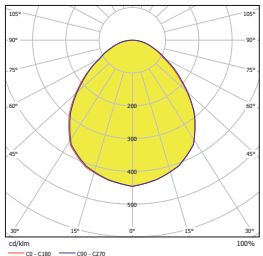

Vert Box Light 100 40 W UGR

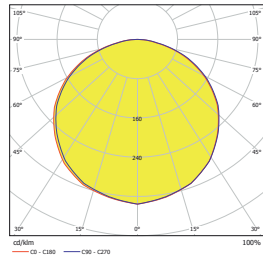

Vert Box Light 100 40 W OP

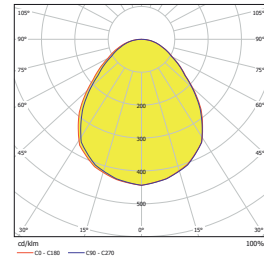

Vert Box Light 144 55W UGR

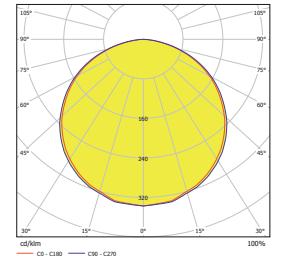

Vert Box Light 144 56W OP

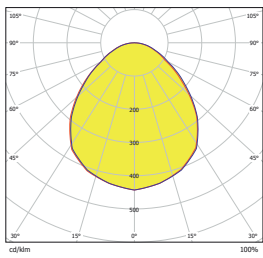

Vert Box Light 200 80 W UGR

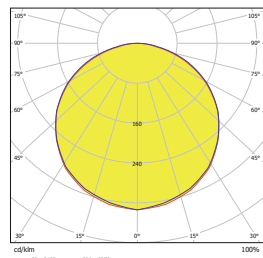

Vert Box Light 200 80 W OP

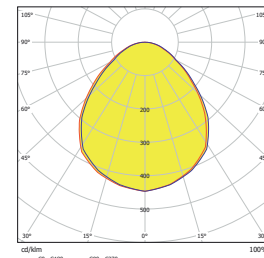

Vert Box Light 265 89 W UGR

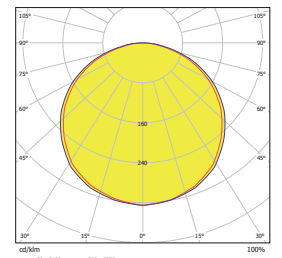

Vert Box Light 265 90 W OP

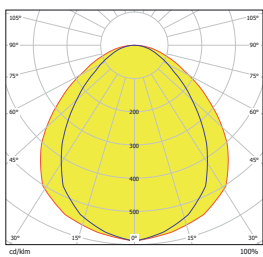

Vert Box Light 100+100 80 W UGR

## SYSTEM ELEMENTS

1. Vert Box Light
2. Vert Box panel
3. T profile
4. Power supply

PERFECT INTEGRATION  
INTO THE VERT - BOX SYSTEM

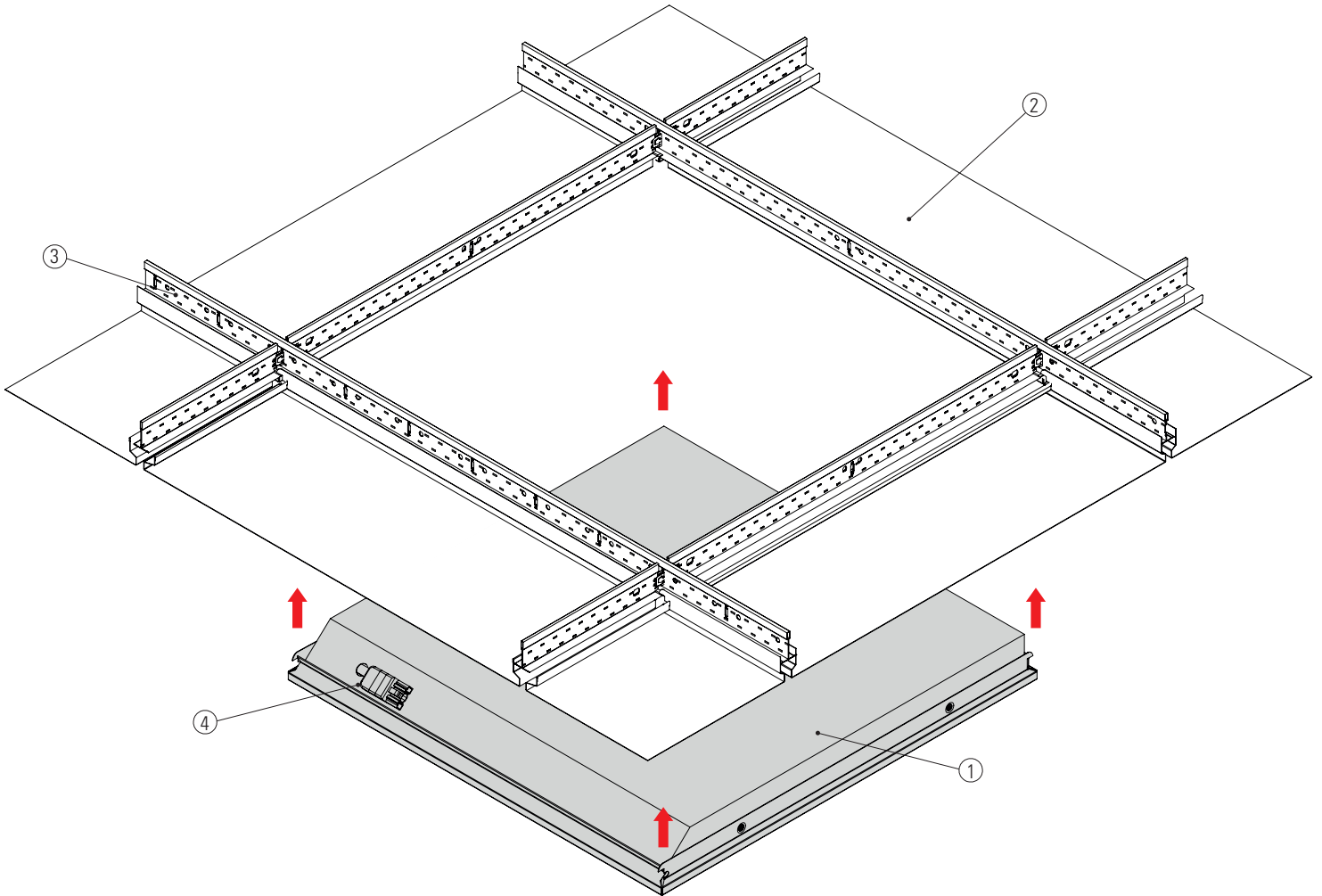

## ASSEMBLY DESCRIPTION

The Vert Box Light ceiling light is assembled in a few simple steps:

1. Insert the ceiling light at an angle.
2. Bring the ceiling light up to level with the structure.
3. Position both hooks at the four corners of the ceiling light in correspondence with the profiles of the structure and bring them into position.

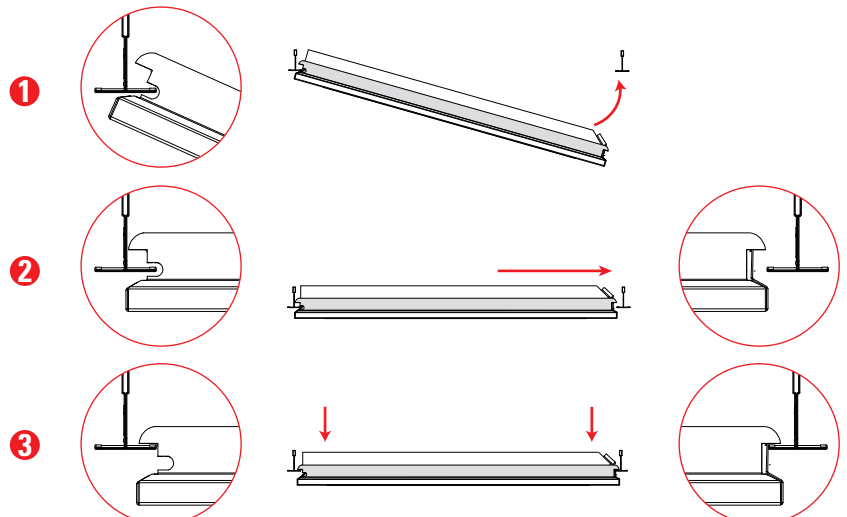

# VIEW OF POSITIONING FROM ABOVE

## SYSTEM ELEMENTS

- 1. Vert Box Light
- 2. Vert Box panel
- 3. T profile
- 4. Power supply
- 5. Suspension

## MOUNTING EXAMPLE ON T-STRUCTURE

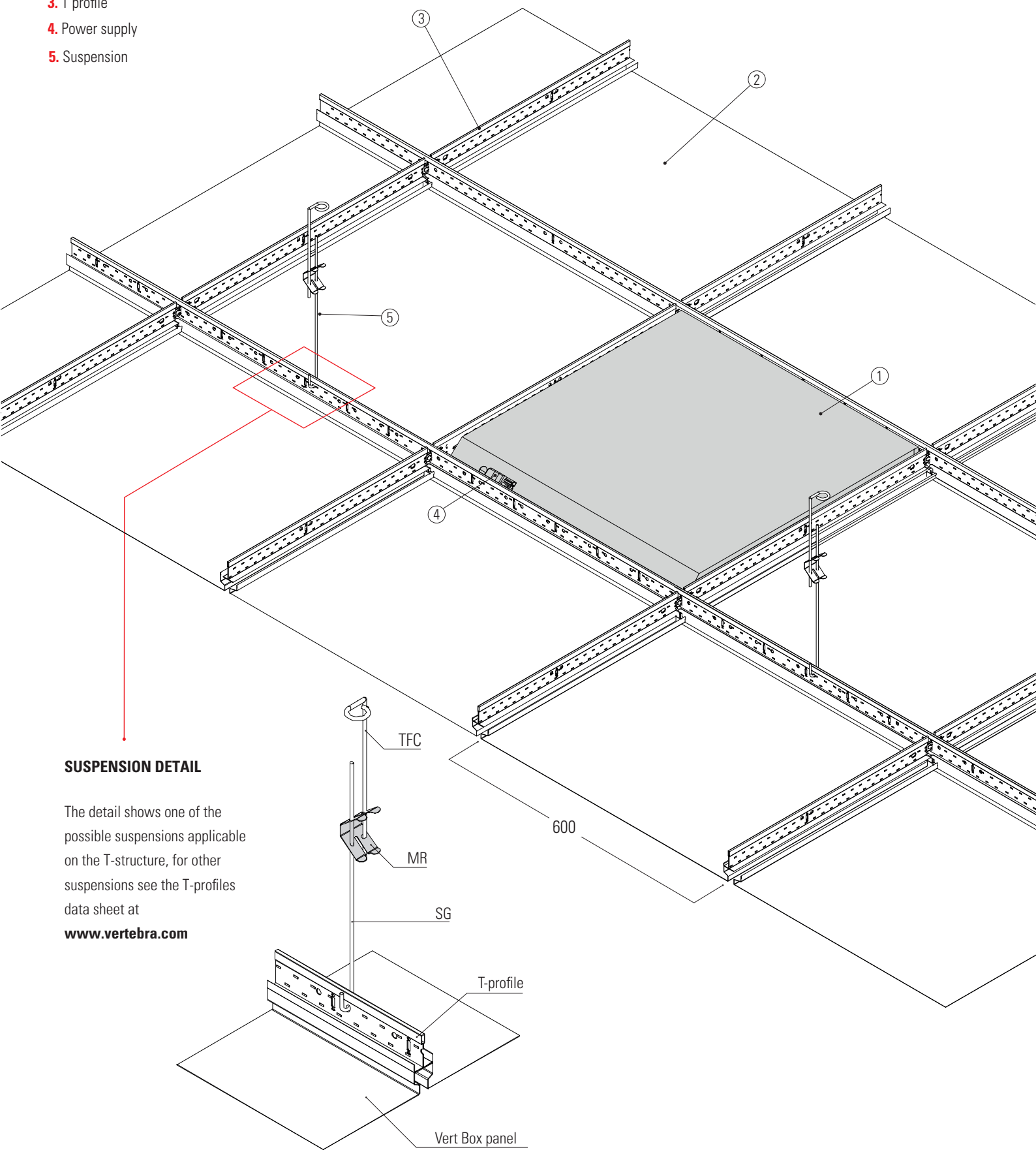

### SUSPENSION DETAIL

The detail shows one of the possible suspensions applicable on the T-structure, for other suspensions see the T-profiles data sheet at

[www.vertebra.com](http://www.vertebra.com)

## A: POWER SUPPLY

230/240 - 50/60 Hz power supply with 0.75 mm<sup>2</sup> cross-section cable and PVC-HT sheathing flame retardant in accordance with CEI 20-35 and complying with CEI 20.20 and CEI CENELEC HD 21 standards. IP66 watertight connector 2P+E or 4P+E, maximum allowed cable cross-section 2.5 mm<sup>2</sup>. Insulation class I. Suitable for installation on normally flammable surfaces.

- Power supply EEI=A2 230-240, 50 - 60Hz. power factor > 0.95.

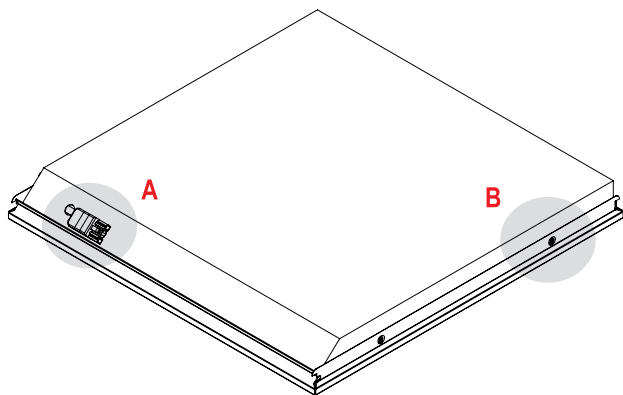

## B: CLOSING BRACKET AND SEAL

Closing bracket consisting of two parts :

- Upper bracket
- Lower sealing bracket on which the guarantee seal is affixed.

It is recommended not to remove the seal, as this would result in the loss of the product warranty.

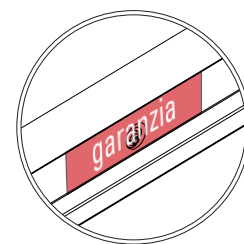

## OTHER EQUIPMENT

Possible equipment of the Microprocessor Self-Test Module equipped with:

- Autonomy test
- Functionality test
- Routine tests

\*\*Luminous flux tolerance  $\pm 10\%$ .

\*Dual Power possibility

\*RGB - DMX/ DALI system with localised touch panel

\*\*Power subject to minor ( $\pm 5\%$ ) variations without notice

\*/\*\* see table page 2

## WARNINGS

### General Warnings

- The luminaire is constructed in a workmanlike manner, and its electrical life will be more than sufficient if used correctly.
- Please read the following warnings carefully as they are important information for safe installation, use and maintenance.
- After removing the appliance from its packaging, ensure that it is undamaged, otherwise contact the seller.
- Packaging elements (plastic bags etc.) must not be left within reach of children as they are potential sources of danger.
- Before connecting the appliance, make sure that the rating plate data correspond to those of the electrical distribution network to which the appliance will be connected (the label with the rating plate data is located on the outside of the appliance).
- Before carrying out any cleaning or maintenance operations, disconnect the appliance from the mains power supply by switching off the circuit breaker; in the event of a fault, contact only professionally qualified personnel.
- Failure to do so may compromise the safety of the appliance.
- The manufacturer cannot be held liable for any damage resulting from improper, incorrect and unreasonable use.

### Important warnings

- The product must not be subject to modification, any modification voids the warranty and may render the product dangerous. Antonio Guerrasio s.r.l. shall not be held liable for any damage caused by its products not being assembled in accordance with the instructions.
- Any damaged components must be replaced with similar ones.
- The products must be installed in a workmanlike manner.
- In order to avoid dangerous overheating, it is recommended not to install the appliance in cramped spaces without air exchange.
- The appliance is also intended for installation on normally flammable surfaces.

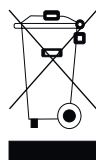

### Recycling

In implementation of Directives 2002/95/EC, 2002/96/EC and 2003/108/EC ("on the reduction of the use of hazardous substances in electrical and electronic equipment and the disposal of waste") the crossed-out wheeled bin serves as a reminder to collect the product separately from other waste at the end of its life or to return it to the retailer when purchasing a new appliance of an equivalent type. This helps to preserve the environment from contamination and promotes the recycling of equipment components. Unauthorised disposal is subject to sanctions in accordance with the law.



IP66



Features subject to change and improvement without notice